

ICC-ES Evaluation Report

ESR-1545

Reissued March 2024

This report also contains:

- LABC Supplement

Subject to renewal March 2026

- FBC Supplement

ICC-ES Evaluation Reports are not to be construed as representing aesthetics or any other attributes not specifically addressed, nor are they to be construed as an endorsement of the subject of the report or a recommendation for its use. There is no warranty by ICC Evaluation Service, LLC, express or implied, as to any finding or other matter in this report, or as to any product covered by the report.

Copyright © 2024 ICC Evaluation Service, LLC. All rights reserved.

<p>DIVISION: 03 00 00— CONCRETE</p> <p>Section: 03 16 00— Concrete Anchors</p> <p>DIVISION: 05 00 00— METALS</p> <p>Section: 05 05 19—Post- Installed Concrete Anchors</p>	<p>REPORT HOLDER: HILTI, INC</p>	<p>EVALUATION SUBJECT: HILTI HSL-3 CARBON STEEL AND HSL-3-R STAINLESS STEEL HEAVY DUTY EXPANSION ANCHORS FOR CRACKED AND UNCRAKED CONCRETE</p>	
--	--	--	---

1.0 EVALUATION SCOPE

Compliance with the following codes:

- 2021, 2018, and 2015 [International Building Code® \(IBC\)](#)
- 2021, 2018, and 2015 [International Residential Code® \(IRC\)](#)

For evaluation for compliance with codes adopted by the [Los Angeles Department of Building and Safety \(LADBS\)](#), see [ESR-1545 LABC and LARC Supplement](#).

Property evaluated:

- Structural

2.0 USES

The Hilti HSL-3 carbon steel and HSL-3-R stainless steel heavy duty expansion anchors are used as anchorage to resist static, wind, and seismic tension and shear loads in cracked and uncracked normal-weight and lightweight concrete having a specified compressive strength $2,500 \text{ psi} \leq f'_c \leq 8,500 \text{ psi}$ ($17.2 \text{ MPa} \leq f'_c \leq 58.6 \text{ MPa}$).

The Hilti HSL-3 and HSL-3-R anchors comply with Section 1901.3 of the 2021, 2018 and 2015 IBC. The anchors may also be used where an engineered design is submitted in accordance with Section R301.1.3 of the IRC.

3.0 DESCRIPTION

3.1 HSL-3 Carbon Steel Heavy Duty Sleeve Anchor:

3.1.1 General: The Hilti HSL-3 Carbon Steel Heavy Duty Expansion Concrete Anchor, designated as the HSL-3, is a torque-set, sleeve-type mechanical expansion anchor. The HSL-3 is comprised of seven components which vary slightly according to anchor diameter, as shown in [Figure 1](#) of this report. It is available in five head configurations, illustrated in [Figure 2](#) of this report.

All carbon steel parts receive a minimum 5 μm (0.0002 inch) thick galvanized zinc plating.

Dimensions and installation criteria are set forth in [Tables 1, 2](#) and [3](#) of this report. Application of torque at the head of the anchor causes the cone to be drawn into the expansion sleeve. This in turn causes the sleeve to expand against the wall of the drilled hole. The ribs on the collapsible element prevent rotation of the sleeve and cone during application of torque. Application of the specified installation torque induces a tension force in the bolt that is equilibrated by a precompression force in the concrete acting through the component being fastened. Telescopic deformation of the collapsible element prevents buildup of precompression in the anchor sleeve in cases where the shear sleeve is in contact with the washer, and permits the closure of gaps between the work surface and the component being fastened. Application of tension loads that exceed the precompression force in the bolt will cause the cone to displace further into the expansion sleeve (follow-up expansion), generating additional expansion force.

3.1.2 HSL-3 (Bolt): The anchor consists of a stud bolt, steel washer, steel sleeve, collapsible plastic sleeve, steel expansion sleeve and steel cone. This anchor is available in carbon steel only. The material specifications are as follows:

- Bolt: Carbon steel per DIN EN ISO 898-1, Grade 8.8
- Washer: Carbon steel per DIN EN 10025.
- Expansion cone: Carbon steel per DIN 1654-4.
- Expansion sleeve: Carbon steel, M8-M16 per DIN 10139, M20-M24 per DIN 2393-2.
- Steel sleeve: Carbon steel per DIN 2393-1.
- Collapsible sleeve: Acetal polyoxymethylene (POM) resin.

3.1.3 HSL-3-G (Stud): The anchor has the same components and material specifications as the HSL-3 (bolt) with the exception that the bolt is replaced by a threaded rod of carbon steel per DIN EN ISO 898-1 Grade 8.8 and a nut of carbon steel per DIN 934 Grade 8. A screwdriver slot is provided on the exposed end of the threaded rod.

3.1.4 HSL-3-B (Torque-Indicator Bolt): The anchor has the same components and material specifications as the HSL-3 (bolt) with the addition of a torque cap nut that permits the proper setting of the anchor without a torque-indicator wrench. The torque cap is zinc alloy complying with DIN 1743. A hexagonal nut is fastened to the bolt head by three countersunk rivets. When the anchor is tightened, the torque is transmitted to the cap. When the torque corresponding to the required anchor expansion is attained, the three countersunk rivets shear off. The torque cap nut breaks free exposing the permanent hex nut.

3.1.5 HSL-3-SH: The anchor has the same components and material specifications as the HSL-3 (bolt) with the exception that the bolt head is configured to accept a hexagonal Allen wrench.

3.1.6 HSL-3-SK: The anchor has the same components and material specifications as the HSL-3 (bolt) except that the bolt head is configured for countersunk applications, is configured to accept a hexagonal Allen wrench and is provided with a conical washer. The bolt is carbon steel per DIN ISO 4759-1 and DIN EN ISO 898-1, Grade 8.8.

3.2 HSL-3-R Stainless Steel Heavy Duty Sleeve Anchor:

3.2.1 General: The Hilti HSL-3-R Stainless Steel Heavy Duty Expansion Concrete Anchor, designated as the HSL-3-R, is a torque-set, sleeve-type mechanical expansion anchor. The HSL-3-R is comprised of seven components which vary slightly according to anchor diameter, as shown in [Figure 1](#) of this report. It is available in three head configurations, illustrated in [Figure 2](#) of this report.

Dimensions and installation criteria are set forth in [Tables 1, 4](#), and [5](#) of this report. Application of torque at the head of the anchor causes the cone to be drawn into the expansion sleeve. This in turn causes the sleeve to expand against the wall of the drilled hole. The ribs on the collapsible element prevent rotation of the sleeve and cone during application of torque. Application of the specified installation torque induces a tension force in the bolt that is equilibrated by a precompression force in the concrete acting through the component being fastened. Telescopic deformation of the collapsible element prevents buildup of precompression in the anchor sleeve in cases where the shear sleeve is in contact with the washer, and permits the closure of gaps between the work surface and the component being fastened. Application of tension loads that exceed the precompression force in the bolt will cause the cone to displace further into the expansion sleeve (follow-up expansion), generating additional expansion force.

3.2.2 HSL-3-R (Bolt): The anchor consists of a stainless steel stud bolt, stainless steel washer, stainless steel sleeve, collapsible plastic sleeve, stainless steel expansion sleeve and stainless steel cone. This anchor is available in stainless steel only. The material specifications are as follows:

- Bolt: Stainless steel per DIN EN 10088-3
- Washer: Stainless steel per DIN EN 10088-3.
- Expansion cone: Stainless steel per ASTM A511/A511M.
- Expansion sleeve: Stainless steel per ASTM A276/A276M.
- Steel sleeve: Stainless steel per ASTM A511/A511M.
- Collapsible sleeve: Acetal polyoxymethylene (POM) resin.

3.2.3 HSL-3-GR (Stud): The anchor has the same components and material specifications as the HSL-3-R (bolt) with the exception that the bolt is replaced by a threaded rod of stainless steel per AISI 316. A screwdriver slot is provided on the exposed end of the threaded rod.

3.2.4 HSL-3-SKR: The anchor has the same components and material specifications as the HSL-3-R (bolt) except that the bolt head is configured for countersunk applications, is configured to accept a hexagonal Allen wrench and is provided with a conical stainless steel washer.

3.3 Concrete:

Normal-weight and lightweight concrete must conform to Sections 1903 and 1905 of the IBC, as applicable.

4.0 DESIGN AND INSTALLATION

4.1 Strength Design:

4.1.1 General: Design strength of anchors complying with the 2021 IBC, as well as Section R301.1.3 of the 2021 IRC must be determined in accordance with ACI 318-19 Chapter 17 and this report.

Design strength of anchors complying with the 2018 and 2015 IBC, as well as Section R301.1.3 of the 2018 and 2015 IRC must be determined in accordance with ACI 318-14 Chapter 17 and this report.

A Design example in accordance with the 2021, 2018 and 2015 IBC is shown in [Figure 6](#) of this report.

Design parameters are based on the 2021 IBC (ACI 318-19), 2018 and 2015 IBC (ACI 318-14) unless noted otherwise in Sections 4.1.1 through 4.1.12 of this report. The strength design of anchors must comply with ACI 318-19 17.5.1.2 or ACI 318-14 17.3.1, as applicable, except as required in ACI 318-19 17.10 or ACI 318-14 17.2.3, as applicable. Strength reduction factors, ϕ , as given in ACI 318-19 17.5.3 or ACI 318-14 17.3.3, as applicable, must be used for load combinations calculated in accordance with Section 1605.1 of the 2021 IBC or Section 1605.2 of the 2018 and 2015 IBC and Section 5.3 of ACI 318 (-19 and-14), as applicable.

The value of f'_c used in the calculations must be limited to a maximum of 8,000 psi (55.2 MPa), in accordance with ACI 318-19 17.3.1 or ACI 318-14 17.2.7, as applicable.

Requirements for Static Steel Strength in **Tension, N_{sa}** : The static steel strength in tension must be calculated in accordance with ACI 318-19 17.6.1.2 or ACI 318-14 17.4.1.2, as applicable. The values for N_{sa} are given in [Table 2](#) and [Table 4](#) of this report. Strength reduction factors, ϕ , corresponding to ductile steel elements may be used for the HSL-3 and HSL-3-R.

4.1.2 Requirements for Static Concrete Breakout Strength in Tension, N_{cb} and N_{cbg} : The nominal concrete breakout strength of a single anchor or group of anchors in tension, N_{cb} and N_{cbg} , respectively must be calculated in accordance with ACI 318-19 17.6.2 or ACI 318-14 17.4.2, as applicable, with modifications as described in this section. The basic concrete breakout strength of a single anchor in tension, N_b , must be calculated in accordance with ACI 318-19 17.6.2.2 or ACI 318-14 17.4.2.2, as applicable, using the values of $h_{ef,min}$ and k_{cr} as given in [Tables 2](#) and [4](#) of this report in lieu of h_{ef} and k_c , respectively. The nominal concrete breakout strength in tension, in regions where analysis indicates no cracking in accordance with ACI 318-19 17.6.2.5 or ACI 318-14 17.4.2.6, as applicable, must be calculated with $\Psi_{c,N} = 1.0$ and using the value of k_{uncr} as given in [Tables 2](#) and [4](#) of this report.

4.1.3 Requirements for Static Pullout Strength in Tension, N_{pn} : The nominal pullout strength of a single anchor, in accordance with ACI 318-19 17.6.3.1 and 17.6.3.2.1 or ACI 318-14 17.4.3.1 and 17.4.3.2, as applicable, in cracked and uncracked concrete, $N_{p,cr}$ and $N_{p,uncr}$, respectively, is given in [Tables 2](#) and [4](#) of this report. In lieu of ACI 318-19 17.6.3.3 or ACI 318-14 17.4.3.6, as applicable, $\Psi_{c,P} = 1.0$ for all design cases. In accordance with ACI 318-19 17.6.3.2.1 or ACI 318-14 17.4.3.2, as applicable, the nominal pullout strength in cracked concrete must be adjusted by calculation according to the following equation:

$$N_{p,f't_c} = N_{p,cr} \sqrt{\frac{f't_c}{2,500}} \quad (\text{lb, psi}) \quad (\text{Eq-1})$$

$$N_{p,f't_c} = N_{p,cr} \sqrt{\frac{f't_c}{17.2}} \quad (\text{N, MPa})$$

In regions where analysis indicates no cracking in accordance with ACI 318-19 17.6.3.3 or ACI 318-14 17.4.3.6, as applicable, the nominal pullout strength in tension must be calculated according to the following equation for all anchors except the HSL-3-R M8:

$$N_{p,ftc} = N_{p,uncr} \sqrt{\frac{f'_c}{2,500}} \quad (\text{lb, psi}) \quad (\text{Eq-2})$$

$$N_{p,ftc} = N_{p,uncr} \sqrt{\frac{f'_c}{17.2}} \quad (\text{N, MPa})$$

For the HSL-3-R M8:

$$N_{p,ftc} = N_{p,uncr} \left(\frac{f'_c}{2500}\right)^{0.1} \quad (\text{lb, psi}) \quad (\text{Eq-3})$$

$$N_{p,ftc} = N_{p,uncr} \left(\frac{f'_c}{17.2}\right)^{0.1} \quad (\text{N, MPa})$$

Where values for $N_{p,cr}$ or $N_{p,uncr}$ are not provided in [Tables 2](#) and [4](#), the pullout strength in tension need not be evaluated.

4.1.4 Requirements for Static Steel Strength in Shear, V_{sa} : The nominal steel strength in shear, V_{sa} , in accordance with ACI 318-19 17.7.1.2 or ACI 318-14 17.5.1.2, as applicable, is given in [Tables 2](#) and [4](#) of this report must be used in lieu of the value derived by calculation from ACI 318-19 Eq. 17.7.1.2b or ACI 318-14 Eq. 17.5.1.2b, as applicable. Strength reduction factors, ϕ , corresponding to ductile steel elements may be used for the HSL-3 and HSL-3-R.

4.1.5 Requirements for Static Concrete Breakout Strength in Shear, V_{cb} or V_{cbg} : The nominal concrete breakout strength in shear of a single anchor or group of anchors, V_{cb} or V_{cbg} , respectively, must be calculated in accordance with ACI 318-19 17.7.2 or ACI 318-14 17.5.2, as applicable, with modifications as provided in this section. The basic concrete breakout strength of a single anchor in shear, V_b , must be calculated in accordance with ACI 318-19 17.7.2.2.1 or ACI 318-14 17.5.2.2, as applicable, using the values of l_e and d_a (d_o) given in [Tables 2](#) and [4](#) of this report.

4.1.6 Requirements for Static Concrete Pryout Strength in Shear, V_{cp} or V_{cpg} : The nominal static concrete pryout strength of a single anchor or group of anchors in shear, V_{cp} or V_{cpg} , must be calculated in accordance with ACI 318-19 17.7.3 or ACI 318-14 17.5.3, as applicable, modified by using the value of k_{cp} provided in [Tables 2](#) and [4](#) of this report and the value of N_{cb} or N_{cbg} as calculated in accordance with Section 4.1.3 of this report.

4.1.7 Requirements for Seismic Design:

4.1.7.1 General: For load combinations including seismic, the design must be performed in accordance with ACI 318-19 17.10 or ACI 318-14 17.2.3, as applicable. Modifications to ACI 318-19 17.10 or ACI 318-14 17.2.3 shall be applied under Section 1905.1.8 of the 2021, 2018 and 2015 IBC, as applicable.

4.1.7.2 Seismic Tension: The nominal steel strength and the nominal concrete breakout strength for anchors in tension must be calculated according to ACI 318-19 17.6.1 and 17.6.2 or ACI 318-14 17.4.1 and 17.4., respectively, as applicable, as described in Sections 4.1.2 and 4.1.3 of this report. In accordance with ACI 318-19 17.6.3.2.1 or ACI 318-14 17.4.3.2, as applicable, the appropriate pullout strength in tension for seismic loads, $N_{p,eq}$, described in [Tables 2](#) and [4](#) must be used in lieu of N_p . The value of $N_{p,eq}$ may be adjusted by calculation for concrete strength in accordance with Eq-1 and Section 4.1.4 whereby the value of $N_{p,eq}$ must be substituted for $N_{p,cr}$. If no values for $N_{p,eq}$ are given in [Tables 2](#) and [4](#), the static design strength values govern.

4.1.7.3 Seismic Shear: The nominal concrete breakout strength and pryout strength for anchors in shear must be calculated according to ACI 318-19 17.7.2 and 17.7.3, or ACI 318-14 17.5.2 and 17.5.3, respectively, as applicable, as described in Sections 4.1.6 and 4.1.7 of this report. In accordance with ACI 318-19 17.7.1.2 or ACI 318-14 17.5.1.2, as applicable, the appropriate value for nominal steel strength for seismic loads, $V_{sa,eq}$ described in [Tables 2](#) and [4](#) must be used in lieu of V_{sa} .

4.1.8 Requirements for Interaction of Tensile and Shear Forces: For anchors or groups of anchors that are subject to the effects of combined tensile and shear forces, the design must be performed in accordance with ACI 318-19 17.8 or ACI 318-14 17.6, as applicable.

4.1.9 Requirements for Critical Edge Distance: In applications where $c < c_{ac}$ and supplemental reinforcement to control splitting of the concrete is not present, the concrete breakout strength in tension for uncracked concrete, calculated according to ACI 318-19 17.6.2 or ACI 318-14 17.4.2, as applicable, must be further multiplied by the factor $\Psi_{cp,N}$ as given by the following equation:

$$\Psi_{cp,N} = \frac{c}{c_{ac}} \quad (\text{Eq-4})$$

where the factor $\Psi_{cp,N}$ need not be taken as less than

$$\frac{1.5 h_{ef}}{c_{ac}}. \text{ For all other cases, } \Psi_{cp,N} = 1.0. \text{ In lieu of ACI 318-19 17.9.5 or ACI 318-14 17.7.6, as applicable,}$$

values for the critical edge distance c_{ac} must be taken from [Tables 3](#) or [5](#) of this report. For the HSL-3 carbon steel anchors, the values $c_{ac,A}$ are valid for a member thickness $h \geq h_{min,A}$ and the values $c_{ac,B}$ for $h_{min,B} \leq h < h_{min,A}$.

4.1.10 Requirements for Minimum Member Thickness, Minimum Anchor Spacing and Minimum Edge Distance: In lieu of ACI 318-19 17.9.2 or ACI 318-14 17.7.1 and 17.7.3, respectively, as applicable, values of s_{min} and c_{min} as given in [Tables 3](#) or [5](#) of this report must be used. In lieu of ACI 318-19 17.9.4 or ACI 318-14 17.7.5, as applicable, minimum member thicknesses h_{min} as given in [Tables 3](#) or [5](#) of this report must be used. Additional combinations for minimum edge distance c_{min} and spacing s_{min} may be derived by linear interpolation between the given boundary values. (See example in [Tables 3](#) or [5](#) and [Figure 4](#) of this report.)

4.1.11 Lightweight Concrete: For the use of anchors in lightweight concrete, the modification factor λ_a equal to 0.8λ is applied to all values of $\sqrt{f'_c}$ affecting N_n and V_n .

For ACI 318-19 (2021 IBC) or ACI 318-14 (2018 and 2015 IBC), λ shall be determined in accordance with the corresponding version of ACI 318.

4.2 Allowable Stress Design (ASD):

4.2.1 General: Design values for use with allowable stress design load combinations calculated in accordance with Section 1605.3 of the IBC shall be established as follows:

$$T_{allowable,ASD} = \frac{\phi N_n}{\alpha} \quad (\text{Eq-5})$$

$$V_{allowable,ASD} = \frac{\phi V_n}{\alpha} \quad (\text{Eq-6})$$

where

Tallowable, ASD = Allowable tension load (lbf or kN)

Vallowable, ASD = Allowable shear load (lbf or kN)

N_n = Lowest design strength of an anchor or anchor group in tension as determined in accordance with ACI 318 (-19 and -14) Chapter 17 and 2021, 2018 and 2015 IBC Section 1905.1.8, and Section 4.1 of this report, as applicable.

V_n = Lowest design strength of an anchor or anchor group in shear as determined in accordance with ACI 318 (-19 and -14) Chapter 17 and 2021, 2018 and 2015 IBC Section 1905.1.8, and Section 4.1 of this report, as applicable.

α = Conversion factor calculated as a weighted average of the load factors for the controlling load combination. In addition, α shall include all applicable factors to account for nonductile failure modes and required over-strength.

The requirements for member thickness, edge distance and spacing, described in this report, must apply. An example of allowable stress design values for illustrative purposes is shown in [Table 6](#).

4.2.2 Requirements for Interaction of Tensile and Shear Forces: The interaction must be calculated and consistent with ACI 318-19 17.8 or ACI 318-14 17.6, as applicable, as follows:

For shear loads $V_{applied} \leq 0.2V_{allowable,ASD}$, the full allowable load in tension $T_{allowable,ASD}$ may be taken.

For tension loads $T_{applied} \leq 0.2T_{allowable,ASD}$, the full allowable load in shear $V_{allowable,ASD}$ may be taken.

For all other cases:

$$\frac{T_{applied}}{T_{allowable,ASD}} + \frac{V_{applied}}{V_{allowable,ASD}} \leq 1.2 \quad (\text{Eq-7})$$

4.3 Installation:

Installation parameters are provided in [Table 1](#) and in [Figure 3](#) of this report. Anchors must be installed per the manufacturer's printed installation instructions, as depicted in [Figure 5](#), and this report. Anchor locations must comply with this report and the plans and specifications approved by the code official. Anchors must be

installed in holes drilled into concrete using carbide-tipped drill bits complying with ANSI B212.15-1994. Alternatively, HSL-3 carbon steel anchors (all variants) may be installed in holes drilled using the Hilti diamond coring tool DD 120 with the DD-BI core bit or with the Hilti diamond coring tool DD EC-1 with the DD-C T2 core bit. Prior to anchor installation, the hole must be cleaned in accordance with the manufacturer's published installation instructions. The nut must be tightened against the washer until the torque values, T_{inst} , specified in [Table 1](#) are achieved.

4.4 Special Inspection:

Periodic special inspection is required, in accordance with Section 1705.1.1 and Table 1705.3 of the 2021, 2018 and 2015 IBC, as applicable. The special inspector must make periodic inspections during anchor installation to verify anchor type, anchor dimensions, concrete type, concrete compressive strength, hole dimensions, anchor spacing, edge distances, concrete thickness, anchor embedment, installation torque, and adherence to the manufacturer's published installation instructions. The special inspector must be present as often as required in accordance with the "statement of special inspection." Under the IBC, additional requirements as set forth in Sections 1705, 1706 and 1707 must be observed, where applicable.

5.0 CONDITIONS OF USE:

The Hilti HSL-3 and HSL-3-R anchors described in this report comply with, or are suitable alternatives to what is specified in, those codes listed in Section 1.0 of this report, subject to the following conditions:

- 5.1 Anchor sizes, dimensions and minimum embedment depths are as set forth in the tables of this report.
- 5.2 The anchors must be installed in accordance with the manufacturer's published installation instructions and this report, in cracked and uncracked normal-weight and lightweight concrete having a specified compressive strength of $f'c = 2,500$ psi to 8,500 psi (17.2 MPa to 58.6 MPa). In case of conflict between this report and the manufacturer's instructions, this report governs.
- 5.3 The values of $f'c$ used for calculation purposes must not exceed 8,000 psi (55.1 MPa).
- 5.4 The concrete shall have attained its minimum design strength prior to installation of the anchors.
- 5.5 Strength design values are established in accordance with Section 4.1 of this report.
- 5.6 Allowable stress design values are established in accordance with Section 4.2 of this report.
- 5.7 Anchor spacing and edge distance as well as minimum member thickness must comply with [Table 4](#) of this report.
- 5.8 Prior to installation, calculations and details demonstrating compliance with this report must be submitted to the code official. The calculations and details must be prepared by a registered design professional where required by the statutes of the jurisdiction in which the project is to be constructed.
- 5.9 Since an ICC-ES acceptance criteria for evaluating data to determine the performance of expansion anchors subjected to fatigue or shock loading is unavailable at this time, the use of these anchors under such conditions is beyond the scope of this report.
- 5.10 Anchors may be installed in regions of concrete where cracking has occurred or where analysis indicates cracking may occur ($f_t > f_{cr}$), subject to the conditions of this report.
- 5.11 Anchors may be used to resist short-term loading due to wind or seismic forces, subject to the conditions of this report.
- 5.12 Where not otherwise prohibited in the code, anchors are permitted for use with fire-resistance-rated construction provided that at least one of the following conditions is fulfilled:
 - Anchors are used to resist wind or seismic forces only.
 - Anchors that support a fire-resistance-rated envelope or a fire-resistance-rated membrane, are protected by approved fire-resistance-rated materials, or have been evaluated for resistance to fire exposure in accordance with recognized standards.
 - Anchors are used to support nonstructural elements.
- 5.13 Use of zinc-coated carbon steel anchors is limited to dry, interior locations.
- 5.14 Special inspection must be provided in accordance with Section 4.4 of this report.
- 5.15 Anchors are manufactured for Hilti, Inc., under an approved quality control program with inspections by ICC-ES.

6.0 EVIDENCE SUBMITTED

Data in accordance with the [ICC-ES Acceptance Criteria for Mechanical Anchors in Concrete Elements \(AC193\)](#), dated October 2017 (editorially revised December 2020), which incorporates requirements in ACI 355.2-19 / ACI 355.2-07, for use in cracked and uncracked concrete, and quality control documentation.

7.0 IDENTIFICATION

- 7.1 The ICC-ES mark of conformity, electronic labeling, or the evaluation report number (ICC-ES ESR-1545) along with the name, registered trademark, or registered logo of the report holder must be included in the product label.
- 7.2 In addition, the anchors are identified by packaging labeled with the evaluation report holder's name (Hilti, Inc.) and address, anchor name, and anchor size. The anchors have the letters HSL-3 or HSL-3-R and the anchor size embossed on the sleeve.
- 7.3 The report holder's contact information is the following:

HILTI, INC.
7250 DALLAS PARKWAY, SUITE 1000
PLANO, TEXAS 75024
(800) 879-8000
www.hilti.com

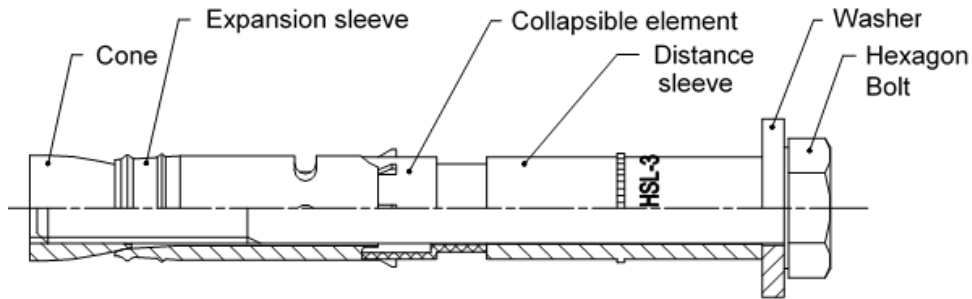

FIGURE 1—COMPONENTS OF THE HSL-3 and HSL-3-R (BOLT VERSION SHOWN)

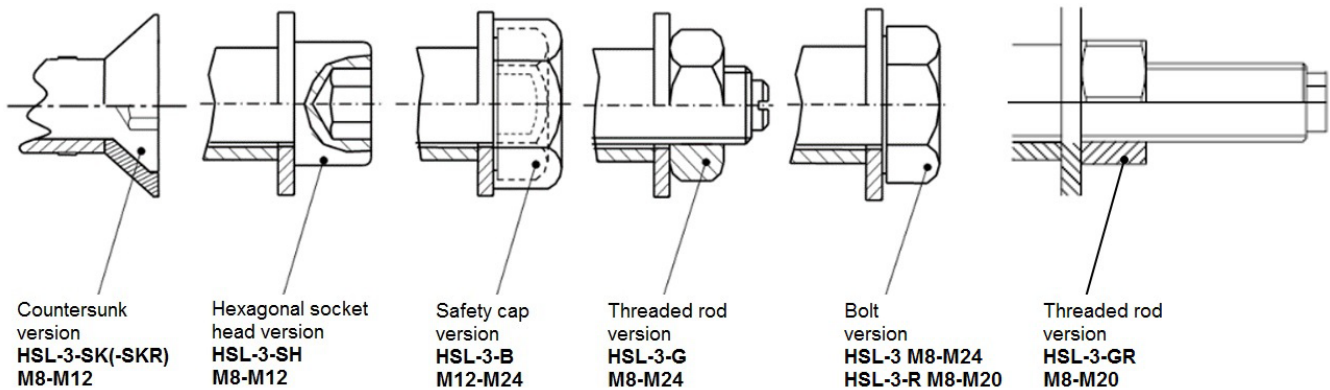

FIGURE 2—HEAD STYLES OF THE HSL-3 and HSL-3-R

TABLE 1—SETTING INFORMATION

Setting Information		Symbol	Units	Nominal anchor diameter					
				M8	M10	M12	M16	M20	M24
Nominal drill bit or core bit diameter ¹		d_{bit}	mm	12	15	18	24	28	32
Minimum hole depth	HSL-3(-R), HSL-3-G(R), HSL-3-B, HSL-3-SK(R)	h_{hole}	mm (in.)	80 (3.15)	90 (3.54)	105 (4.13)	125 (4.92)	155 (6.10)	180 (7.09)
	HSL-3-SH	h_{hole}	mm (in.)	85 (3.35)	95 (3.74)	110 (4.33)			
Clearance hole diameter in part being fastened		d_f	mm (in.)	14 (0.55)	17 (0.67)	20 (0.79)	26 (1.02)	31 (1.22)	35 (1.38)
Max. cumulative gap between part(s) being fastened and concrete surface		-	mm (in.)	4 (0.16)	5 (0.20)	8 (0.31)	9 (0.35)	12 (0.47)	16 (0.63)
Washer diameter HSL-3(-R), HSL-3-G(R), HSL-3-B		d_w	mm (in.)	20 (0.79)	25 (0.98)	30 (1.18)	40 (1.57)	45 (1.77)	50 (1.97)
Installation torque	HSL-3	T_{inst}	Nm (ft-lb)	25 (18)	50 (37)	80 (59)	120 (89)	200 (148)	250 (185)
	HSL-3-R		Nm (ft-lb)	25 (18)	35 (26)	80 (59)	120 (89)	200 (148)	
	HSL-3-G		Nm (ft-lb)	20 (15)	35 (26)	60 (44)	80 (59)	160 (118)	180 (132)
	HSL-3-GR		Nm (ft-lb)	30 (22)	50 (37)	80 (59)	120 (89)	200 (148)	
	HSL-3-SK		Nm (ft-lb)	25 (18)	50 (37)	80 (59)			
	HSL-3-SKR		Nm (ft-lb)	18 (13)	50 (37)	80 (59)			
	HSL-SH		Nm (ft-lb)	20 (15)	35 (26)	60 (44)			
Wrench size	HSL-3(-R), HSL-3-G(R)	SW	mm	13	17	19	24	30	36
	HSL-3-B	SW	mm			24	30	36	41
Allen wrench size	HSL-3-SK(R)	SW	mm	5	6	8			
	HSL-3-SH	SW	mm	6	8	10			
Diameter of countersunk hole HSL-3-SK(R)		d_{sk}	mm (in.)	22.5 (0.89)	25.5 (1.00)	32.9 (1.29)			

For pound-inch units: 1 mm = 0.03937 inches, 1 Nm = 0.7376 ft-lbf.

¹Use metric bits only.

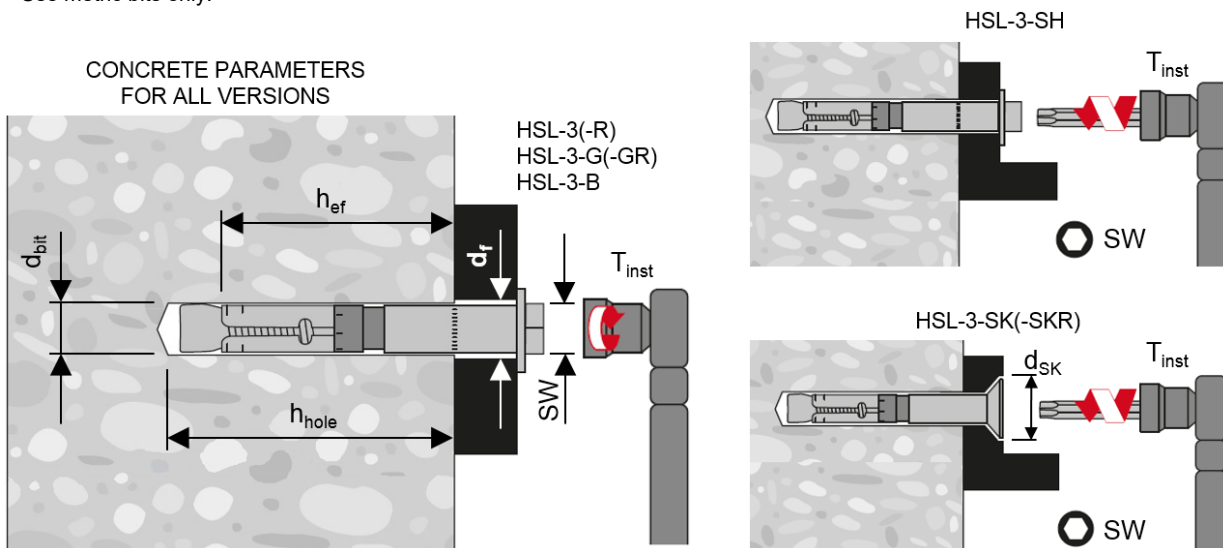

FIGURE 3—HSL-3 AND HSL-3-R IN THE INSTALLED CONDITION

TABLE 2—DESIGN INFORMATION FOR CARBON STEEL HSL-3 (ALL VERSIONS)

Design parameter	Symbol	Units	Nominal anchor diameter					
			M8	M10	M12	M16	M20	M24
Anchor O.D.	d_a	mm in.	12 (0.47)	15 (0.59)	18 (0.71)	24 (0.94)	28 (1.10)	32 (1.26)
Effective min. embedment depth ¹	$h_{ef,min}$	mm in.	60 (2.36)	70 (2.76)	80 (3.15)	100 (3.94)	125 (4.92)	150 (5.91)
Anchor category ²	1, 2 or 3	-	1	1	1	1	1	1
Strength reduction factor for tension, steel failure modes ³	ϕ	-	0.75					
Strength reduction factor for shear, steel failure modes ³	ϕ	-	0.65					
Strength reduction factor for tension, concrete failure modes ³	ϕ	Cond.A	0.75					
		Cond.B	0.65					
Strength reduction factor for shear, concrete failure modes ³	ϕ	Cond.A	0.75					
		Cond.B	0.70					
Yield strength of anchor steel	f_{ya}	lb/in ² (N/mm ²)	92,800 (640)					
Ultimate strength of anchor steel	f_{uta}	lb/in ² (N/mm ²)	116,000 (800)					
Tensile stress area	$A_{se,N}$	in ² (mm ²)	0.057 (36.6)	0.090 (58.0)	0.131 (84.3)	0.243 (157.0)	0.380 (245.0)	0.547 (353.0)
Steel strength in tension	N_{sa}	lb (kN)	6,612 (29.4)	10,440 (46.4)	15,196 (67.6)	28,188 (125.4)	44,080 (196.1)	63,452 (282.2)
Effectiveness factor uncracked concrete	k_{uncr}	- (SI)	24 (10)	24 (10)	24 (10)	24 (10)	24 (10)	24 (10)
Effectiveness factor cracked concrete ⁴	k_{cr}	- (SI)	17 (7.1)	24 (10)	24 (10)	24 (10)	24 (10)	24 (10)
Modification factor for cracked and uncracked concrete ⁵	$\psi_{C,N}$	-	1.00	1.00	1.00	1.00	1.00	1.00
Pullout strength uncracked concrete ⁶	$N_{p,uncr}$	lb (kN)	4,204 (18.7)	NA	NA	NA	NA	NA
Pullout strength cracked concrete ⁶	$N_{p,cr}$	lb (kN)	2,810 (12.5)	4,496 (20.0)	NA	NA	NA	NA
Steel strength in shear HSL-3,-B,-SH,-SK	V_{sa}	lb (kN)	7,239 (32.2)	10,229 (45.5)	14,725 (65.5)	26,707 (118.8)	39,521 (175.8)	45,951 (204.4)
Steel strength in shear HSL-3-G		lb (kN)	6,070 (27.0)	8,385 (37.3)	12,162 (54.1)	22,683 (100.9)	33,159 (147.5)	43,169 (192.0)
Coefficient for pryout strength	k_{cp}	-	1.0	2.0				
Load bearing length of anchor in shear	ℓ_e	mm (in.)	24 (0.94)	30 (1.18)	36 (1.42)	48 (1.89)	56 (2.20)	64 (2.52)
Tension pullout strength seismic ⁷ HSL-3,-B,-SH,-SK	$N_{p,eq}$	lb (kN)	2,810 (12.5)	4,496 (20.0)	NA	NA	NA	14,320 (63.7)
Tension pullout strength seismic ⁷ HSL-3-G		lb (kN)	2,810 (12.5)	4,496 (20.0)	NA	NA	NA	
Steel strength in shear, seismic ⁷ HSL-3,-B,-SH,-SK	$V_{sa,eq}$	lb (kN)	4,609 (20.5)	8,453 (37.6)	11,892 (52.9)	24,796 (110.3)	29,135 (129.6)	38,173 (169.8)
Steel strength in shear, seismic ⁷ HSL-3-G		lb (kN)	3,777 (16.8)	6,924 (30.8)	9,824 (43.7)	21,065 (93.7)	24,459 (108.8)	
Axial stiffness in service load range ⁸	uncracked concrete	β_{uncr}	300					
	cracked concrete	β_{cr}	30	70	130	130	130	130

For SI: 1 inch = 25.4 mm, 1 lbf = 4.45 N, 1 psi = 0.006895 MPa. For pound-inch units: 1 mm = 0.03937 inches.

¹See Table 1.

²See ACI 318-19 17.5.3 or ACI 318-14 17.3.3, as applicable.

³The strength reduction factor applies when the load combinations from the IBC or ACI 318 are used and the requirements of ACI 318-19 17.5.3 or ACI 318-14 17.3.3, as applicable, are met.

⁴See ACI 318-19 17.6.2.2 or ACI 318-14 17.4.2.2, as applicable.

⁵See ACI 318-19 17.6.2.5 or ACI 318-14 17.4.2.6, as applicable.

⁶NA (not applicable) denotes that this value does not control for design. See Section 4.1.4 of this report.

⁷NA (not applicable) denotes that this value does not control for design. See Section 4.1.8 of this report.

⁸Minimum axial stiffness values, maximum values may be 3 times larger (e.g., due to high-strength concrete).

TABLE 3—CARBON STEEL EDGE DISTANCE, SPACING AND MEMBER THICKNESS REQUIREMENTS^{1,2}

Case	Dimensional parameter	Symbol	Units	Nominal anchor diameter					
				M8	M10	M12	M16	M20	M24
A	Minimum concrete thickness	$h_{min,A}$	in. (mm)	4 ³ / ₄ (120)	5 ¹ / ₂ (140)	6 ¹ / ₄ (160)	7 ⁷ / ₈ (200)	9 ⁷ / ₈ (250)	11 ⁷ / ₈ (300)
A	Critical edge distance ²	$C_{ac,A}$	in. (mm)	4 ³ / ₈ (110)	4 ³ / ₈ (110)	4 ³ / ₄ (120)	5 ⁷ / ₈ (150)	8 ⁷ / ₈ (225)	8 ⁷ / ₈ (225)
A	Minimum edge distance ³	$C_{min,AA}$	in. (mm)	2 ³ / ₈ (60)	2 ³ / ₄ (70)	3 ¹ / ₂ (90)	4 ³ / ₄ (120)	5 (125)	5 ⁷ / ₈ (150)
A	Minimum anchor spacing ³	$S_{min,AA}$	in. (mm)	5 ¹ / ₂ (140)	9 ¹ / ₂ (240)	11 (280)	12 ⁵ / ₈ (320)	13 ³ / ₄ (350)	11 ⁷ / ₈ (300)
A	Minimum edge distance ³	$C_{min,AB}$	in. (mm)	3 ³ / ₈ (85)	5 (125)	6 ¹ / ₈ (155)	7 ⁷ / ₈ (200)	8 ¹ / ₄ (210)	8 ¹ / ₄ (210)
A	Minimum anchor spacing ³	$S_{min,AB}$	in. (mm)	2 ³ / ₈ (60)	2 ³ / ₄ (70)	3 ¹ / ₈ (80)	4 (100)	5 (125)	5 ⁷ / ₈ (150)
B	Minimum concrete thickness	$h_{min,B}$ ⁴	in. (mm)	4 ³ / ₈ (110)	4 ³ / ₄ (120)	5 ³ / ₈ (135)	6 ¹ / ₄ (160)	7 ¹ / ₂ (190)	8 ⁷ / ₈ (225)
B	Critical edge distance ²	$C_{ac,B}$	in. (mm)	5 ⁷ / ₈ (150)	6 ⁷ / ₈ (175)	7 ⁷ / ₈ (200)	9 ⁷ / ₈ (250)	12 ³ / ₈ (312.5)	14 ³ / ₄ (375)
B	Minimum edge distance ³	$C_{min,BA}$	in. (mm)	2 ³ / ₈ (60)	3 ¹ / ₂ (90)	4 ³ / ₈ (110)	6 ¹ / ₄ (160)	7 ⁷ / ₈ (200)	8 ⁷ / ₈ (225)
B	Minimum anchor spacing ³	$S_{min,BA}$	in. (mm)	7 (180)	10 ¹ / ₄ (260)	12 ⁵ / ₈ (320)	15 (380)	15 ³ / ₄ (400)	15 (380)
B	Minimum edge distance ³	$C_{min,BB}$	in. (mm)	4 (100)	6 ¹ / ₄ (160)	7 ⁷ / ₈ (200)	10 ⁵ / ₈ (270)	11 ⁷ / ₈ (300)	12 ⁵ / ₈ (320)
B	Minimum anchor spacing ³	$S_{min,BB}$	in. (mm)	2 ³ / ₈ (60)	2 ³ / ₄ (70)	3 ¹ / ₈ (80)	4 (100)	5 (125)	5 ⁷ / ₈ (150)

For SI: 1 inch = 25.4 mm.

¹See Section 4.1.10 of this report.

²See Section 4.1.11 of this report.

³Denotes admissible combinations of h_{min} , C_{ac} , C_{min} and s_{min} . For example, $h_{min,A} + C_{ac,A} + C_{min,AA} + S_{min,AA}$ or $h_{min,A} + C_{ac,A} + C_{min,AB} + S_{min,AB}$ are admissible, but $h_{min,A} + C_{ac,B} + C_{min,AB} + S_{min,BB}$ is not. However, other admissible combinations for minimum edge distance C_{min} and spacing s_{min} for $h_{min,A}$ or $h_{min,B}$ may be derived by linear interpolation between boundary values (see example for $h_{min,A}$ below).

⁴For the HSL-3-SH M8, M10 and M12 diameters, the minimum slab thickness $h_{min,B}$ must be increased by 5 mm (³/₁₆").

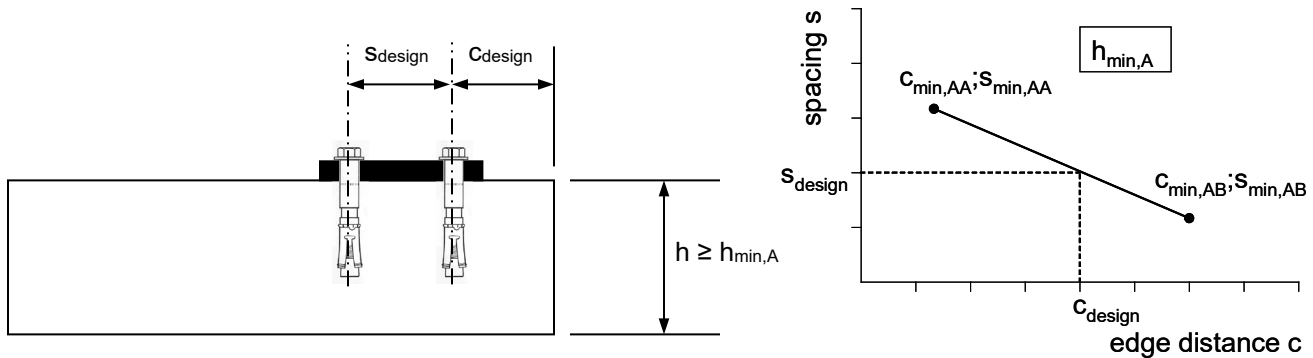

FIGURE 4—EXAMPLE OF ALLOWABLE INTERPOLATION OF MINIMUM EDGE DISTANCE AND MINIMUM SPACING

TABLE 4—DESIGN INFORMATION FOR STAINLESS STEEL HSL-3-R (ALL VERSIONS)

Design parameter	Symbol	Units	Nominal anchor diameter					
			M8	M10	M12	M16	M20	
Anchor O.D.	d_a	mm (in.)	12 (0.47)	15 (0.59)	18 (0.71)	24 (0.94)	28 (1.10)	
Effective min. embedment depth ¹	$h_{ef,min}$	mm in.	60 (2.36)	70 (2.76)	80 (3.15)	100 (3.94)	125 (4.92)	
Anchor category ²	1,2 or 3	-	3	2	2	1	1	
Strength reduction factor for tension, steel failure modes ³	ϕ	-	0.75					
Strength reduction factor for shear, steel failure modes ³	ϕ	-	0.65					
Strength reduction factor for tension, concrete failure modes ³	ϕ	Cond.A	0.55	0.65	0.65	0.75	0.75	
		Cond.B	0.45	0.55	0.55	0.65	0.65	
Strength reduction factor for shear, concrete failure modes ³	ϕ	Cond.A	0.75					
		Cond.B	0.70					
Yield strength of anchor steel, HSL-3-R	f_{ya}	lb/in ² (N/mm ²)	81,200 (560)	65,300 (450)				
Yield strength of anchor steel, HSL-3-GR		lb/in ² (N/mm ²)	81,200 (560)					
Yield strength of anchor steel, HSL-3-SKR		lb/in ² (N/mm ²)	81,200 (560)	65,300 (450)				
Ultimate strength of anchor steel	f_{uta}	lb/in ² (N/mm ²)	101,500 (700)					
Tensile stress area	A_{se}	in ² (mm ²)	0.057 (36.6)	0.090 (58.0)	0.131 (84.3)	0.243 (157.0)	0.380 (245.0)	
Steel strength in tension	N_{sa}	lb (kN)	5,760 (25.6)	9,127 (40.6)	13,266 (59.0)	24,707 (109.9)	38,555 (171.5)	
Effectiveness factor uncracked concrete	k_{unscr}	- (SI)	24 (10.0)	24 (10.0)	24 (10.0)	27 (11.3)	30 (12.6)	
Effectiveness factor cracked concrete ⁴	k_{cr}	- (SI)	17 (7.1)	21 (8.8)	24 (10.0)	24 (10.0)	24 (10.0)	
Modification factor for cracked and uncracked concrete ⁵	$\psi_{C,N}$	-	1.0	1.0	1.0	1.0	1.0	
Pullout strength uncracked concrete ⁶	$N_{p,unscr}$	lb (kN)	3,777 (16.8)	NA	NA	NA	NA	
Pullout strength cracked concrete ⁶	$N_{p,cr}$	lb (kN)	NA	4,539 (20.2)	NA	NA	11,868 (52.8)	
Steel strength in shear HSL-3-R	V_{sa}	lb (kN)	9,982 (44.4)	14,096 (62.7)	18,300 (81.4)	28,821 (128.2)	32,642 (145.2)	
Steel strength in shear HSL-3-GR		lb (kN)	9,060 (40.3)	13,264 (59.0)	17,715 (78.8)	29,135 (129.6)	35,970 (160.0)	
Steel strength in shear HSL-3-SKR		lb (kN)	9,982 (44.4)	14,096 (62.7)	18,300 (81.4)			
Coefficient for pryout strength	k_{cp}	-	1.0	2.0	2.0	2.0	2.0	
Load bearing length of anchor in shear	l_e	mm (in.)	24 (0.94)	30 (1.18)	36 (1.42)	48 (1.89)	56 (2.20)	
Tension pullout strength seismic ⁷	$N_{p,eq}$	lb (kN)	3,080 (13.7)	4,539 (20.2)	6,699 (29.8)	9,375 (41.7)	11,868 (52.8)	
Steel strength in shear, seismic ⁷	$V_{sa,eq}$	lb (kN)	2,720 (12.1)	6,632 (29.5)	7,082 (31.5)	14,388 (64.0)	14,388 (64.0)	
Axial stiffness in service load range ⁸	uncracked concrete	β_{unscr}	10 ³ lb/in.	805	822	377	817	874
	cracked concrete	β_{cr}		120	177	148	45	143

For SI: 1 inch = 25.4 mm, 1 lbf = 4.45 N, 1 psi = 0.006895 MPa. For pound-inch units: 1 mm = 0.03937 inches.

¹See Table 1.

²See ACI 318-19 17.5.3 or ACI 318-14 17.3.3, as applicable.

³The strength reduction factor applies when the load combinations from the IBC or ACI 318 are used and the requirements of ACI 318-19 17.5.3 or ACI 318-14 17.3.3, as applicable, are met.

⁴See ACI 318-19 17.6.2.2 or ACI 318-14 17.4.2.2, as applicable.

⁵See ACI 318-19 17.6.2.5 or ACI 318-14 17.4.2.6, as applicable.

⁶NA (not applicable) denotes that this value does not control for design. See Section 4.1.4 of this report.

⁷NA (not applicable) denotes that this value does not control for design. See Section 4.1.8 of this report.

⁸Minimum axial stiffness values, maximum values may be 3 times larger (e.g., due to high-strength concrete).

TABLE 5—STAINLESS STEEL EDGE DISTANCE, SPACING AND MEMBER THICKNESS REQUIREMENTS^{1,2}

Case	Dimensional parameter	Symbol	Units	Nominal anchor diameter				
				M8	M10	M12	M16	M20
A	Minimum concrete thickness	$h_{min,A}$	in. (mm)	4 ³ / ₄ (120)	5 ¹ / ₂ (140)	6 ¹ / ₄ (160)	7 ⁷ / ₈ (200)	9 ⁷ / ₈ (250)
A	Critical edge distance ²	$C_{ac,A}$	in. (mm)	7 ⁷ / ₈ (200)	11 (280)	8 ⁵ / ₈ (220)	9 ¹ / ₂ (240)	15 (380)
A	Minimum edge distance ³	$C_{min,AA}$	in. (mm)	2 ³ / ₄ (70)	3 ¹ / ₂ (90)	3 ¹ / ₂ (90)	4 (100)	5 ⁷ / ₈ (150)
A	Minimum anchor spacing ³	$S_{min,AA}$	in. (mm)	5 ¹ / ₂ (140)	6 ¹ / ₄ (160)	9 ⁷ / ₈ (250)	9 ¹ / ₂ (240)	11 ⁷ / ₈ (300)
A	Minimum edge distance ³	$C_{min,AB}$	in. (mm)	4 ³ / ₄ (120)	5 ¹ / ₈ (130)	6 ¹ / ₄ (160)	9 ¹ / ₂ (240)	11 ⁷ / ₈ (300)
A	Minimum anchor spacing ³	$S_{min,AB}$	in. (mm)	2 ³ / ₄ (70)	3 ¹ / ₂ (90)	4 (100)	4 (100)	5 (125)

For SI: 1 inch = 25.4 mm

¹See Section 4.1.10 of this report.

²See Section 4.1.11 of this report.

³Denotes admissible combinations of h_{min} , C_{ac} , C_{min} and S_{min} . For example, $h_{min,A} + C_{ac,A} + C_{min,AA} + S_{min,AA}$ or $h_{min,A} + C_{ac,A} + C_{min,AB} + S_{min,AB}$ are admissible, but $h_{min,A} + C_{ac,A} + C_{min,AB} + S_{min,AA}$ is not. However, other admissible combinations for minimum edge distance C_{min} and spacing S_{min} for $h_{min,A}$ may be derived by linear interpolation between boundary values (see example for $h_{min,A}$ in [Figure 4](#)).

TABLE 6—EXAMPLE ALLOWABLE STRESS DESIGN VALUES FOR ILLUSTRATIVE PURPOSES^{1,2,3,4,5,6,7,8,9,10}

Nominal Anchor Diameter	Effective Embedment		Allowable Tension (lbs)
	mm	inches	$f'_c = 2500$ psi
M8	60	2.36	1,846
M10	70	2.76	2,417
M12	80	3.15	2,946
M16	100	3.94	4,122
M20	125	4.92	5,751
M24	150	5.91	7,572

¹Single anchor with static tension load only.

²Concrete determined to remain uncracked for the life of the anchorage.

³Load combinations from ACI 318 (-19 and -14) Section 5.3, as applicable (no seismic loading).

⁴30% dead load and 70% live load, controlling load combination 1.2D + 1.6L

⁵Calculation of weighted average for $\alpha = 0.3 \cdot 1.2 + 0.7 \cdot 1.6 = 1.48$

⁶ $f'_c = 2,500$ psi (normal weight concrete).

⁷ $C_{a1} = C_{a2} \geq C_{ac}$

⁸ $h \geq h_{min}$

⁹Values are for where supplementary reinforcement in accordance with ACI 318-19 17.5.3 or ACI 318-14 17.3.3(c) is not provided, as applicable.

¹⁰ ϕ factor is 0.65.

HSL-3 carbon steel and HSL-3-R stainless steel anchors

HSL-3 carbon steel anchors only with diamond core drilling

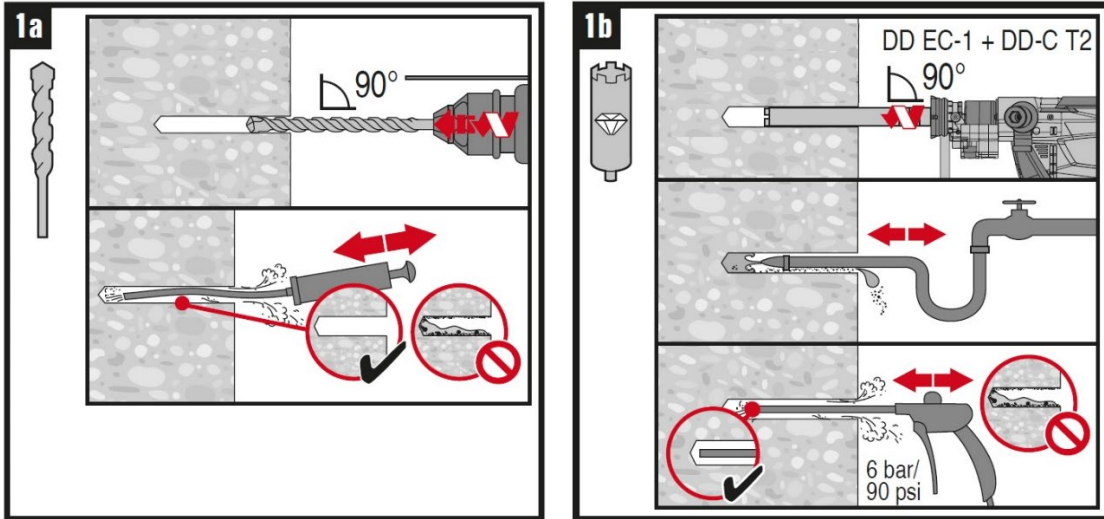

HSL-3(-R)



HSL-3-G(-GR)

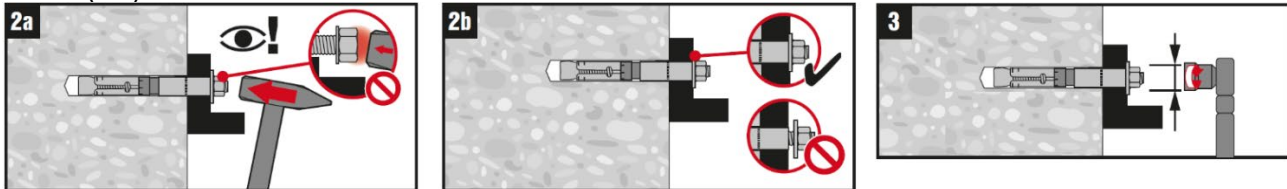

HSL-3-B

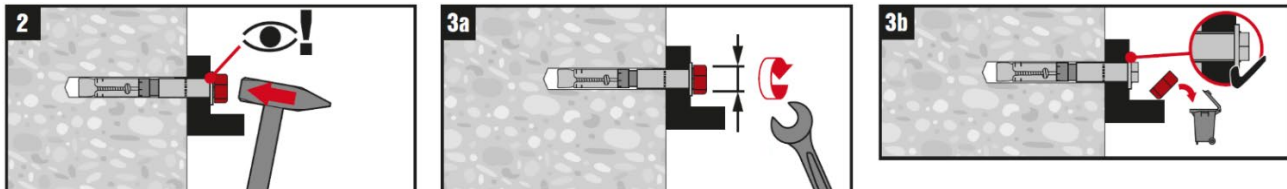

HSL-3-SK(-SKR)



HSL-3-SH



FIGURE 5—MANUFACTURER'S PRINTED INSTALLATION INSTRUCTIONS

Given:

Two HSL-3 M10 anchors under static tension load as shown.

$h_{ef} = 2.76$ in.

Normal weight concrete with $f'_c = 3,000$ psi.

No supplementary reinforcement.

(ACI 318-19 17.5.3 or ACI 318-14 17.3.3(c))

Assume uncracked normal-weight concrete.

Needed:

Using Allowable Stress Design (ASD) Calculate the allowable tension load for this configuration.

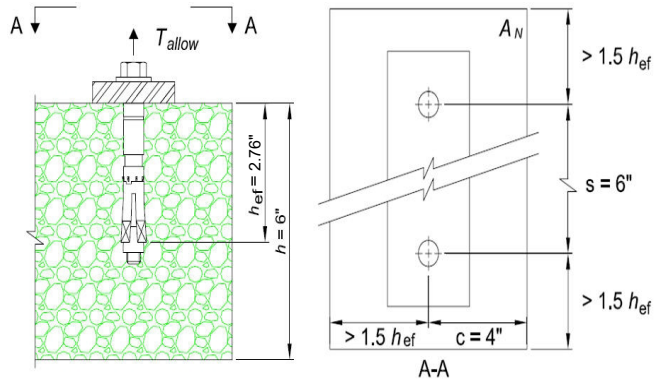

Calculation per ACI 318 (-19 or -14) Chapter 17 and this report.	ACI 318-19 Ref.	ACI 318-14 Ref.	Report Ref.	
Step 1. Calculate steel strength of anchor in tension $N_{sa} = nA_{se,N}f_{uta} = 2 \times 0.090 \times 116,000 = 20,880$ lb	17.6.1.2	17.4.1.2	Table 3	
Step 2. Calculate steel capacity $\Phi N_{sa} = 0.75 \times 20,880 = 15,600$ lb	17.5.3(a)	17.3.3(a)	Table 3	
Step 3. Calculate concrete breakout strength of anchor in tension $N_{cbg} = \frac{A_{Nc}}{A_{Nco}} \psi_{ec,N} \psi_{ed,N} \psi_{c,N} \psi_{cp,N} N_b$	17.6.2.1	17.4.2.1	§4.1.3	
Step 4. Verify minimum spacing and edge distance: Table 4 Case A: $h_{min} = 5-1/2$ in. < 6 in. okay slope = $\frac{9.5 - 2.75}{2.75 - 5} = -3.0$ For $c_{min} = 4$ in. <input type="checkbox"/> $s_{min} = 9.5 - [(4 - 2.75)(-3.0)] = 5.75$ in. < 6 in. <input type="checkbox"/> okay		17.9	17.7	Table 3 Table 4
Step 5. Calculate A_{Nco} and A_{Nc} for the anchorage: $A_{Nco} = 9h_{ef}^2 = 9(2.76)^2 = 68.6$ in ² $A_{Nc} = (1.5h_{ef} + c)(3h_{ef} + s) = [1.5(2.76) + 4][3(2.76) + 6] = 116.2$ in ² < $2A_{Nco}$ ∴ okay	17.6.2.1	17.4.2.1	Table 3	
Step 6. Calculate $N_b = k_{unscr} \lambda_a \sqrt{f'_c} h_{ef}^{1.5} = 24(1.0)\sqrt{3,000}(2.76)^{1.5} = 6,027$ lb	17.6.2.2	17.4.2.2	Table 3	
Step 7. Modification factor for eccentricity → no eccentricity $e'_N = 0$ ∴ $\psi_{ec,N} = 1.0$	17.6.2.3	17.4.2.4	-	
Step 8. Modification factor for edge $1.5h_{ef} = 1.5(2.76) = 4.13$ in. > c <input type="checkbox"/> $\psi_{ed,N}$ must be calculated: $\psi_{ed,N} = 0.7 + 0.3 \frac{4}{1.5(2.76)} = 0.99$	17.6.2.4	17.4.2.5	Table 3	
Step 9. Modification factor for cracked concrete, $k = 24$ used in D.5.2.2 → $\psi_{c,N} = 1.0$ (see Step 10)	17.6.2.5	17.4.2.6	Table 3	
Step 10. Splitting Modification factor $\psi_{cp,N} = \frac{\max\{c \square 1.5 h_{ef}\}}{c_{ac}} = \frac{1.5(2.76)}{4.375} = 0.94$	17.6.2.6	17.4.2.7	Table 4	
Step 11. Calculate $N_{cbg} = \frac{116.2}{68.6} \times 1.0 \times 0.99 \times 1.0 \times 0.94 \times 6,027 = 9,500$ lb	17.6.2.1	17.4.2.1	-	
Step 12. Check pullout strength in Table 3 → $N_{p,unscr}$ does not govern	17.6.3.2	17.4.3.2	§ 4.1.4 Table 3	
Step 13. $\Phi N_{cbg} = 0.65 \times 9,500 = 6,175$ lb < ΦN_s <input type="checkbox"/> ΦN_{cbg} controls	17.5.3(c)	17.3.3(c)	Table 3	
Step 14. To convert to ASD, assume $U = 1.2D + 1.6L$: $T_{allow} = \frac{6,175}{1.48} = 4,172$ lb.	-	-	§ 4.2	

FIGURE 6—EXAMPLE CALCULATION

DIVISION: 03 00 00—CONCRETE

Section: 03 16 00—Concrete Anchors

DIVISION: 05 00 00—METALS

Section: 05 05 19—Post-Installed Concrete Anchors

REPORT HOLDER:

HILTI, INC.

EVALUATION SUBJECT:

HILTI HSL-3 CARBON STEEL AND HSL-3-R STAINLESS STEEL HEAVY DUTY EXPANSION ANCHORS FOR CRACKED AND UNCRACKED CONCRETE

1.0 REPORT PURPOSE AND SCOPE

Purpose:

The purpose of this evaluation report supplement is to indicate that the Hilti HSL-3 carbon steel and HSL-3-R stainless steel heavy duty expansion anchors in cracked and uncracked concrete, described in ICC-ES evaluation report [ESR-1545](#), have also been evaluated for compliance with the codes noted below as adopted by the Los Angeles Department of Building and Safety (LADBS).

Applicable code editions:

- 2023 *City of Los Angeles Building Code* (LABC)
- 2023 *City of Los Angeles Residential Code* (LARC)

2.0 CONCLUSIONS

The Hilti HSL-3 carbon steel and HSL-3-R stainless steel heavy duty expansion anchors, described in Sections 2.0 through 7.0 of the evaluation report [ESR-1545](#), comply with LABC Chapter 19, and the LARC, and are subjected to the conditions of use described in this supplement.

3.0 CONDITIONS OF USE

The Hilti HSL-3 carbon steel and HSL-3-R stainless steel heavy duty expansion anchors described in this evaluation report supplement must comply with all of the following conditions:

- All applicable sections in the evaluation report [ESR-1545](#).
- The design, installation, conditions of use and identification of the anchors are in accordance with the 2021 *International Building Code*® (IBC) provisions noted in the evaluation report [ESR-1545](#).
- The design, installation and inspection are in accordance with additional requirements of LABC Chapters 16 and 17, and City of Los Angeles Information Bulletin P/BC 2020-092, as applicable.
- Under the LARC, an engineered design in accordance with LARC Section R301.1.3 must be submitted.
- The allowable and strength design values listed in the evaluation report and tables are for the connection of the anchors to the concrete. The connection between the anchors and the connected members shall be checked for capacity (which may govern).
- For the design of wall anchorage assemblies to flexible diaphragms, the anchor shall be designed per the requirements of City of Los Angeles Information Bulletin P/BC 2020-071

This supplement expires concurrently with the evaluation report, reissued March 2024.

DIVISION: 03 00 00—CONCRETE

Section: 03 16 00—Concrete Anchors

DIVISION: 05 00 00—METALS

Section: 05 05 19—Post-Installed Concrete Anchors

REPORT HOLDER:

HILTI, INC.

EVALUATION SUBJECT:**HILTI HSL-3 CARBON STEEL AND HSL-3-R STAINLESS STEEL HEAVY DUTY EXPANSION ANCHORS FOR CRACKED AND UNCRACKED CONCRETE****1.0 REPORT PURPOSE AND SCOPE****Purpose:**

The purpose of this evaluation report supplement is to indicate that the Hilti HSL-3 carbon steel and HSL-3-R stainless steel heavy duty expansion anchors in cracked and uncracked concrete, described in ICC-ES evaluation report ESR-1545, have also been evaluated for compliance with the codes noted below.

Applicable code editions:

- 2023 Florida Building Code—Building
- 2023 Florida Building Code—Residential

2.0 CONCLUSIONS

The Hilti HSL-3 carbon steel and HSL-3-R stainless steel heavy duty expansion anchors in cracked and uncracked concrete, described in Sections 2.0 through 7.0 of ICC-ES evaluation report ESR-1545, comply with the *Florida Building Code—Building* and the *Florida Building Code—Residential*, provided the design requirements are determined in accordance with the *Florida Building Code—Building* or the *Florida Building Code—Residential*, as applicable. The installation requirements noted in ICC-ES evaluation report ESR-1545 for the 2021 *International Building Code*® meet the requirements of the *Florida Building Code—Building* or the *Florida Building Code—Residential*, as applicable.

Use of the Hilti HSL-3 carbon steel and HSL-3-R stainless steel heavy duty expansion anchors in cracked and uncracked concrete have also been found to be in compliance with the High-Velocity Hurricane Zone provisions of the *Florida Building Code—Building* or the *Florida Building Code—Residential*, with the following condition:

- a) For anchorage of wood members, the connection subject to uplift must be designed for no less than 700 pounds (3114 N).
- b) For connection to aluminum members, all expansion anchors must be installed no less than 3 inches from the edge of concrete slab and/or footings. All expansion anchors shall develop an ultimate withdrawal resisting force equal to four times the imposed load, with no stress increase for duration of load.

For products falling under Florida Rule 61G20-3, verification that the report holder's quality assurance program is audited by a quality assurance entity approved by the Florida Building Commission for the type of inspections being conducted is the responsibility of an approved validation entity (or the code official when the report holder does not possess an approval by the Commission).

This supplement expires concurrently with the evaluation report, reissued March 2024.